

KARIBAN

K4029

Ecologische kindersweater met capuchon

- Trendy en ecologisch.
- Gemaakt van 3 LSF-draden (Low Shrinkage Fleece) : sterk en wasbestendig
- No label : 100% personaliseerbaar naar uw merk.

85% katoen / 15% polyester. Gemaakt van 85% biologisch katoen en 15% gerecycled polyester post-consumer. Buitenoppervlak 100% katoen. Geborsteld fleece 3 draden LSF (Low Shrinkage Fleece) aan de binnenkant. Gekamd katoen. Enzymgewassen. Rechte snit. 1x1 ribboord in buisconstructie voor een betere afwerking aan de mouwuiteinden en de onderkant. Kangoeroezak. Gevoerde capuchon 100% katoen, jerseykatoen 180 g. Nektape in toon-op-toon jersey en halvemaanvormige afwerking aan de binnenkant van de kraag. Afwerking met dubbel stiksel aan mouwuiteinden en onderkant. Geen merklablet in de kraag, maar enkel een maatlabel voor eenvoudige personalisatie. Gemiddeld gewicht in maat 8/10 : 328g.



4/6 ans 6/8 ans 8/10 ans 10/12 ans 12/14 ans  280 g/m²



Certificaten



Made with 85% Organic materials
Certified by Ecocert Greenlife
EGL N°183963 / TOPTEx Belgique

STANDARD 100
CQ 1007/7
IFTH
www.oeko-tex.com



Aanvullende informatie

Logistieke informatie



5



20



BD - Bangladesh

HS-codes



61102099

Bestaat ook in

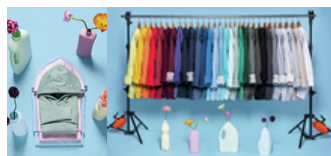

K4028

K4027

KARIBAN

K4029

Ecologische kindersweater met capuchon

Afmeting

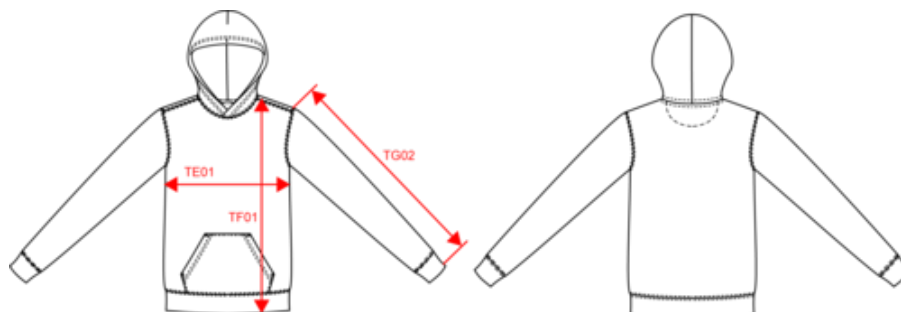











Measurements in cm	4/6 ans	6/8 ans	8/10 ans	10/12 ans	12/14 ans
TE01 - 1/2 chest width at 1.5cm below armhole	36.70	38.40	41.00	44.50	48.00
TF01 - Total height from HSP	45.90	50.70	55.50	60.30	65.10
TG02 - Long sleeve length	40.65	44.85	49.25	53.85	58.45

KARIBAN

K4029

Ecologische kindersweater met capuchon

Kleurinformatie

 Black RVB : 35,35,37 Pantone C : Black Pantone TCX : 19-4004TCX	 Clay RVB : 188,180,174 Pantone C : 7535C Pantone TCX : 15-4502TCX	 Dark Grey RVB : 63,60,60 Pantone C : 447C Pantone TCX : 19-0000TCX	 Forest Green RVB : 41,62,48 Pantone C : 5605C Pantone TCX : 19-5918TCX	 Light Orange RVB : 240,119,60 Pantone C : 7578C Pantone TCX : 17-1360TCX
 Light Royal Blue RVB : 53,95,151 Pantone C : 653C Pantone TCX : 18-4041TCX	 Navy RVB : 41,46,56 Pantone C : 433C Pantone TCX : 19-4012TCX	 Oxford Grey RVB : Pantone C : Based on Cool gray 7C Pantone TCX : Based on 16-3850TCX	 Red RVB : 195,32,54 Pantone C : 200C Pantone TCX : 19-1664TCX	 Sage RVB : 153,172,163 Pantone C : 5635C Pantone TCX : 16-5304TCX
 White RVB : 236,236,252 Pantone C : White Pantone TCX : 11-0601TCX				

Logistieke informatie

 5  20

Sizes	Width (cm)	Height (cm)	Length (cm)	Net weight (kg)	Gross weight (kg)	Pieces/Box	Pieces/Bundle
4/6 ans	40.00000	28.00000	60.00000	5.80000	7.30000	20	5
6/8 ans	40.00000	28.00000	60.00000	6.40000	7.90000	20	5
8/10 ans	40.00000	30.00000	60.00000	7.20000	8.70000	20	5
10/12 ans	40.00000	30.00000	60.00000	8.00000	9.50000	20	5
12/14 ans	40.00000	30.00000	60.00000	8.80000	10.30000	20	5